

DETAIL A
SCALE 1 : 5

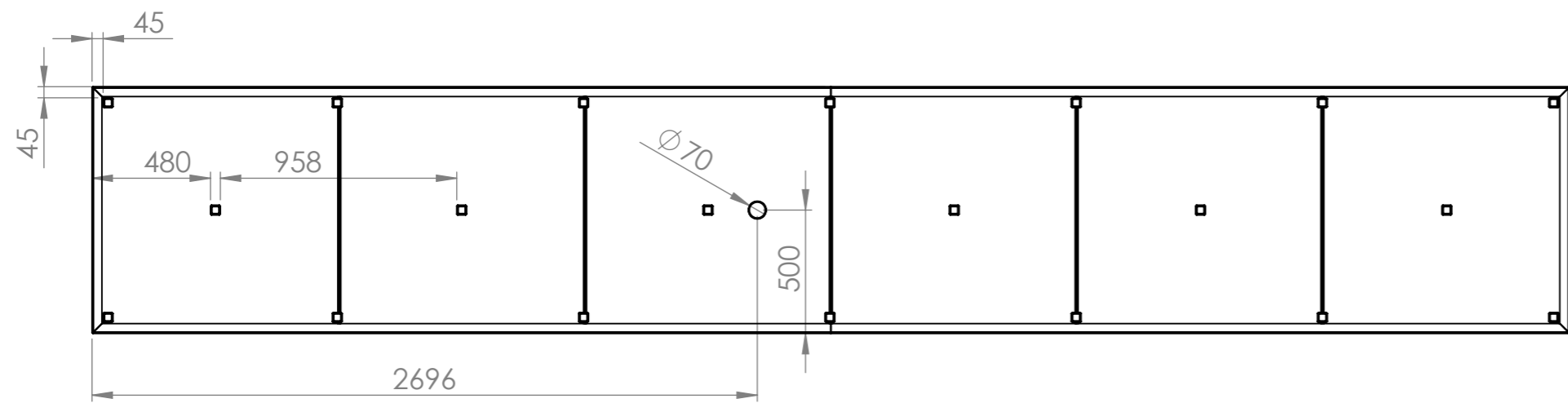

ITEM NO.	PART NUMBER	Thickness	DESCRIPTION	Def ault /QT Y.
1	CB1. Base	3 mm	Corten	1
2	CB1. Cover	3 mm	Corten	1

DRAWN	Joris Koppens	DATE	10-10-2019
REVISION			



TITLE:
3mm Corten



Liessentstraat 4, 5405 AG Uden (NL).
t 0031 (0)413 - 27 41 68.
e info@adezz.com, i www.adezz.com



Drawing: **CB1. 6000x1000x400** A3

Only use supplied rods to support the lid
(store these rods well, outside the water table)

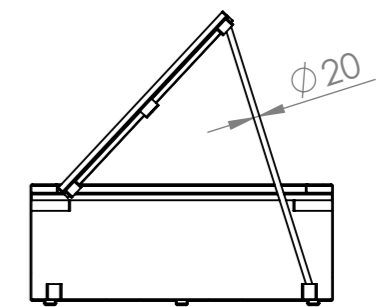
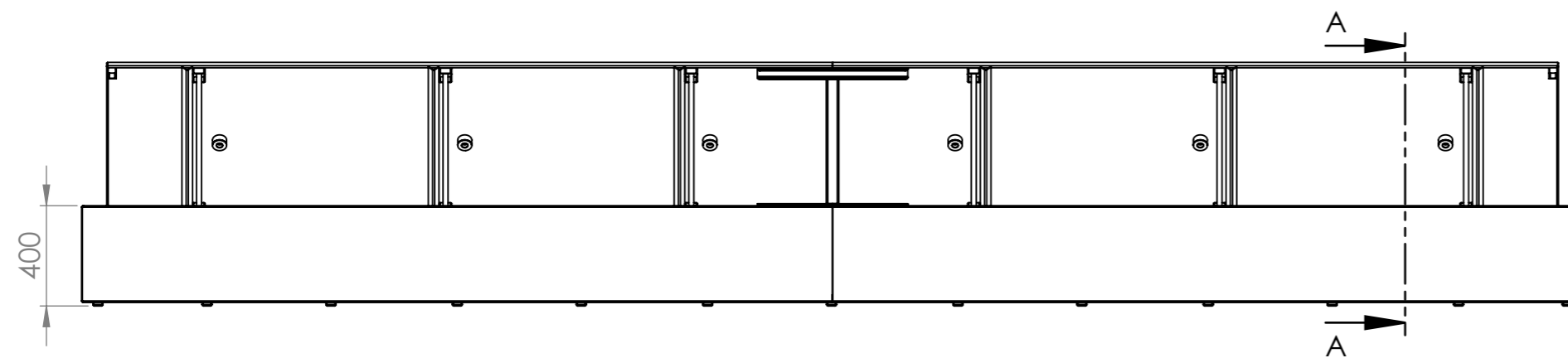
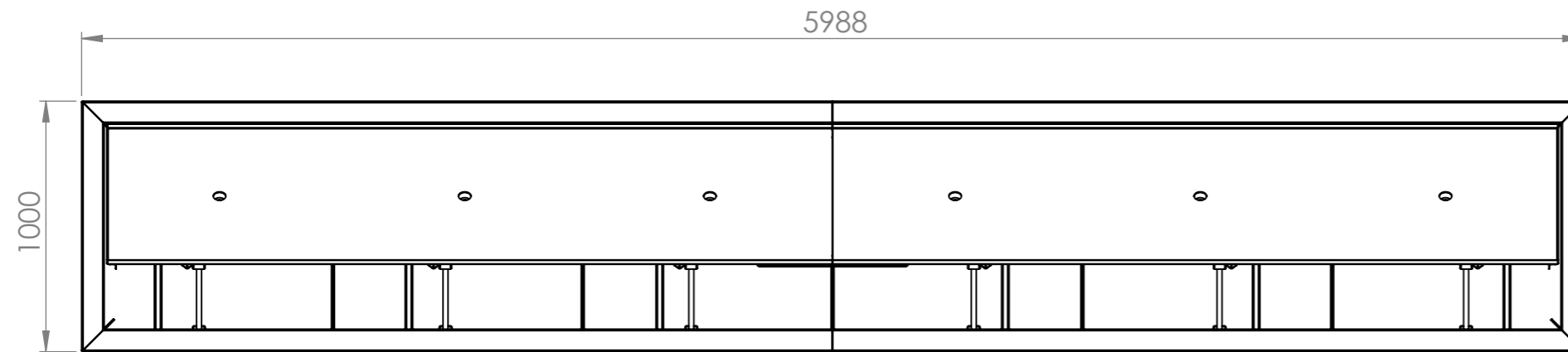
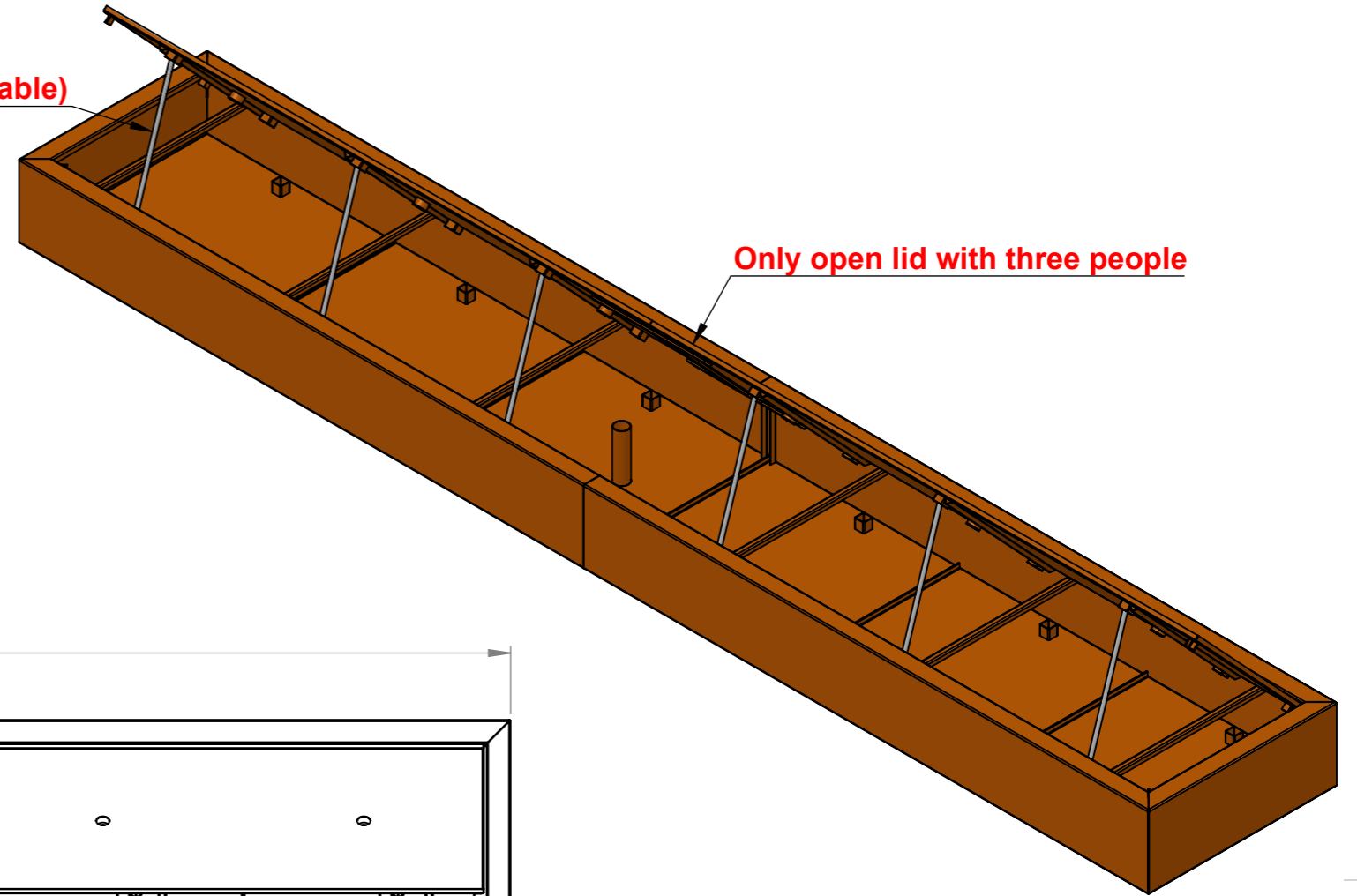
Only open lid with three people



SECTION A-A

DRAWN	Joris Koppens	DATE	10-10-2019		TITLE:	3mmCorten	
REVISION					Drawing:	CB1. 6000x1000x400	A3
		Liessentstraat 4, 5405 AG Uden (NL). t 0031 (0)413 - 27 41 68. e info@adezz.com, i www.adezz.com		Color:	-	Mass (kg):	453.20
				SCALE:1:25	SHEET 2 OF 25		